

OPERATING INSTRUCTIONS

MILKOTESTER

MILK ANALYZING DEVICE

Service manual: MASTER PRO

P1 and P2 included

*Fat, Solids-Non-Fat (SNF), Protein, Lactose, Water content,
Temperature (°C), Freezing point, Salts, Density, pH*



**THE INFORMATION CONTAINED IN THIS MANUAL IS A SUBJECT TO CHANGE
WITHOUT NOTICE. FOR UPDATES, PLEASE CONTACT THE MANUFACTURER
OR USE THE FOLLOWING WEB ADDRESS:**

<http://www.milkotester.com>

CAUTION!

**This device operates on 100-250V. In order to avoid electrical shock or to prevent the unit from damage
DO NOT REMOVE the cover!
Please follow the instructions in this manual!**

Safety recommendations :

- **Read carefully and make sure you understand all the instructions.**
- **After initially turning ON the device do recommend 3-4 cycles of "Clean"**
- **Place the device on a leveled and stable surface. If it falls or is severely shocked its functional systems may be damaged.**
- **When plugging the device into the electrical outlet, put away the power cord so it does not stay in the way when accessing the device and cannot be stepped on.**
- **Do not disassemble the device in order to avoid possible electrical shock. In case of malfunction contact your local dealer.**
- **Handle the liquids the device works with carefully, following all the instructions for their preparation.**

Table of contents

1. General description.....	4
2. Close-up view.....	5
2.1 Front panel.....	5
2.2 Display.....	6
2.3 Rear Panel.....	7
3. Samples preparation.....	9
4. Working description.....	11
4.1 Preparing the device.....	11
4.2 Measuring samples.....	12
4.3 Making corrections.....	14
5. Determination of the milk and Calibration.....	18
5.1 Representative samples from milk and other milk derivatives for milk analyzer's calibration.....	18
5.1.1 General.....	18
5.1.2 Necessary quality parameters values determination.....	19
5.1.3 Advisable scheme for independently determination the content of different parameters in milk and its derivatives.....	24
5.2 Calibration.....	27
6. Settings and options.....	32
6.1 Settings, options and memory.....	32
6.2 Measurement of pH.....	34
6.5 Thermometer.....	40
6.3 Measurement of Conductivity.....	41
6.4 Method of determination and calibration.....	42
7. Cleaning and maintenance.....	43
7.1 Routine cleaning.....	43
7.2 Complete flushing.....	44
7.3 Weekly cleaning.....	44
7.4 Peristaltic pump service.....	46
8. Troubleshooting.....	47
9. Technical specifications.....	48
Appendix Freezing point determination.....	50
Appendix internal printer.....	53
Connecting to external printer.....	54
PC connection.....	55
Bluetooth.....	57
Flash drive.....	60
Warranty card.....	63

CHAPTER ONE

1

General description

MILKOTESTER MASTER is designed for percentage analysis of Fat, Solids-Non-Fat (SNF), Protein, Lactose, Water content, Temperature (°C), Freezing point, Salts, Density and pH. These components can all be measured at the same time. The device measures cow milk, sheep milk, buffalo milk, camel milk, lama milk, restored milk, UHT, cream, whey and buttermilk.

The factory preset is for cow milk, sheep milk and UHT. Upon user's request the device can be calibrated for any of the above mentioned types of milk.

The device has a compact design with a robust structure and a user-friendly interface. Most importantly, the one-button operation is extremely simple – you press only once to start measuring, you press only once for cleaning. Master PRO can analyze three types of milk defined by user. The measurement speed is 50 samples per hour with cleaning included. The samples are precisely dosed and small quantities are required – the sample volume is 25 cm³. No thermal or mechanical treatment of the samples before analysis is necessary. No use of chemical reagents is required. The working conditions are as follows – temperatures from 5° to 35 °C, HR from 30% to 80%.

With regard to the “moisture problem” which remains of much significance the front panel of the device is designed to operate when with wet hands. In addition to this Master PRO, Milkotester LTD provides one year full warranty.

CHAPTER TWO

2

Close-up view

IN THIS CHAPTER

- Front panel
 - Display
 - Rear panel
-

2.1 Front panel

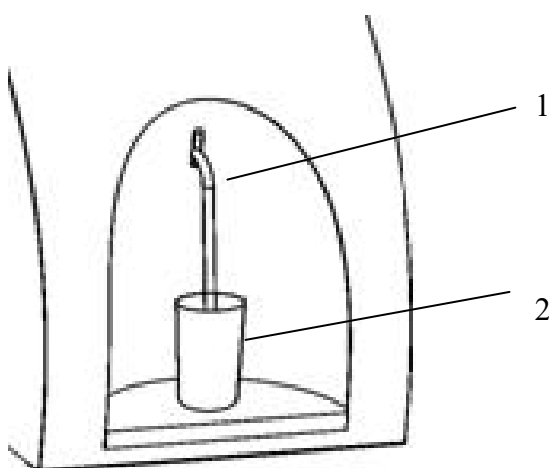

- 1 – Intake pipette**
2 – Sample cup

Close-up view

2.2 Display

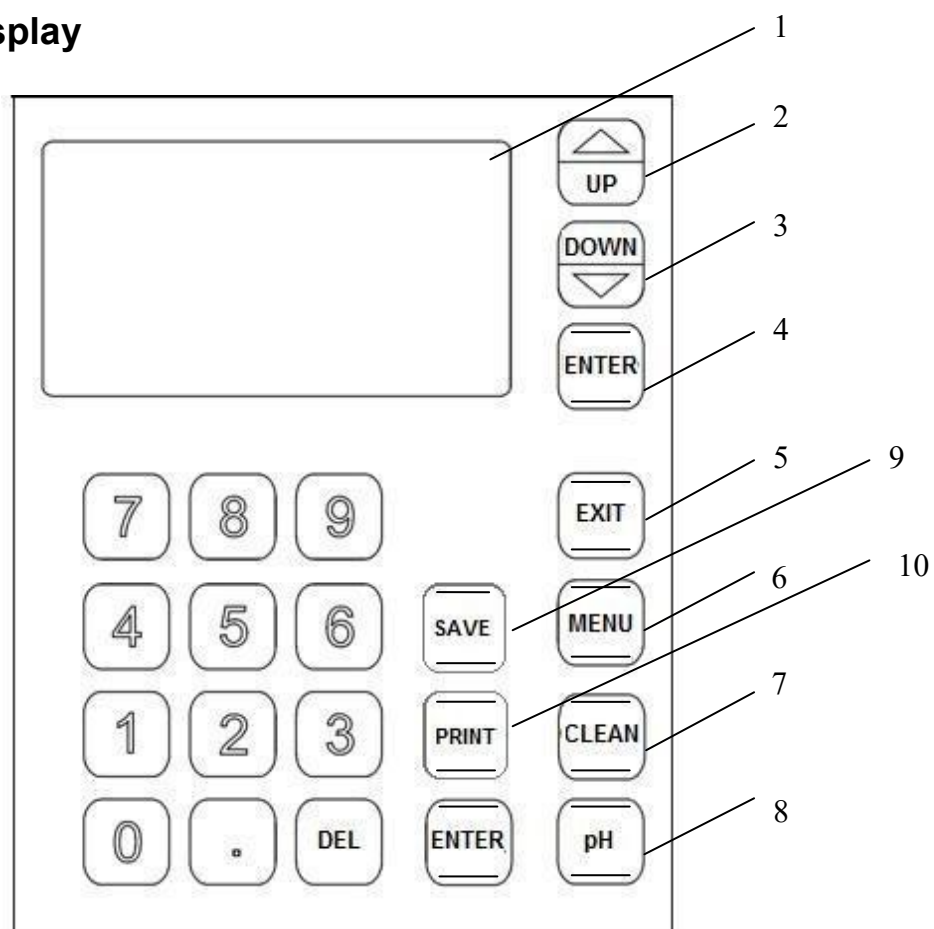

- 1 – LCD
- 2 – Arrow UP button
- 3 – Arrow DOWN button
- 4 – ENTER button
- 5 – EXIT button
- 6 – MENU button
- 7 – CLEAN button
- 8 – pH measurement (active only on request)
- 9 – SAVE button
- 10 – PRINT button

2.3. Rear Panel

2.3.1 Rear panel Master Pro – P1

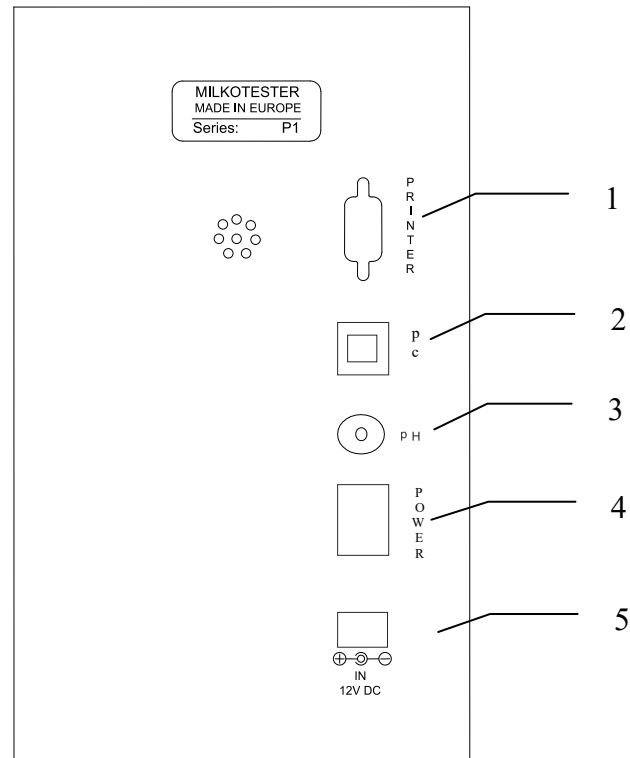

- 1 – Serial port to printer**
- 2 – Serial port PC**
- 3 – pH connector(option)**
- 4 – Power switch**
- 5 – Power 'IN' socket 12V DC**

2.3.2 Rear Panel Master Pro – P2

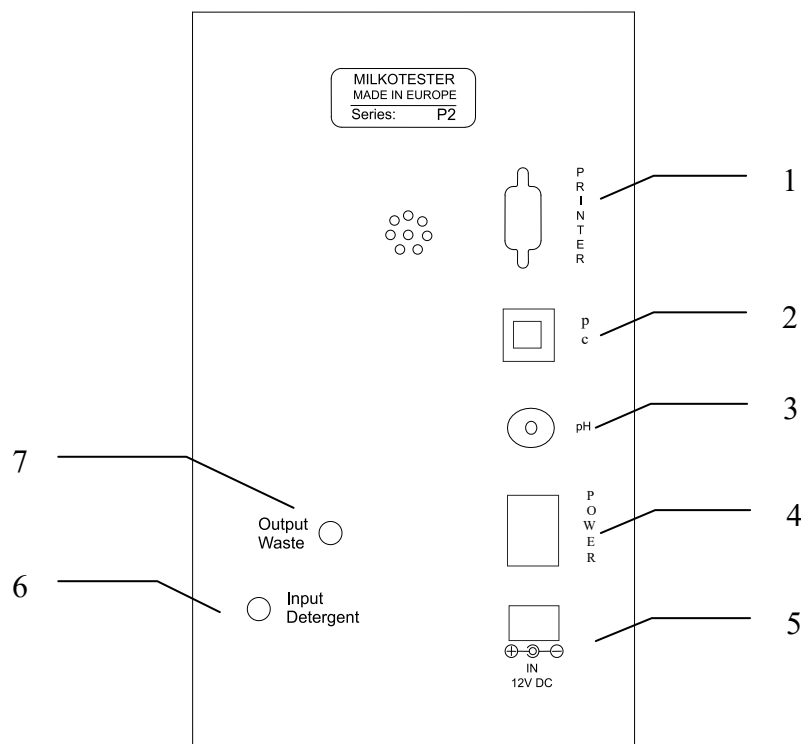

- 1 – Serial port to printer
- 2 – Serial port to PC
- 3 – pH connector (option)
- 4 – Power switch
- 5 – Power 'IN' socket 12V DC
- 6 – Input Detergent

Output Waste

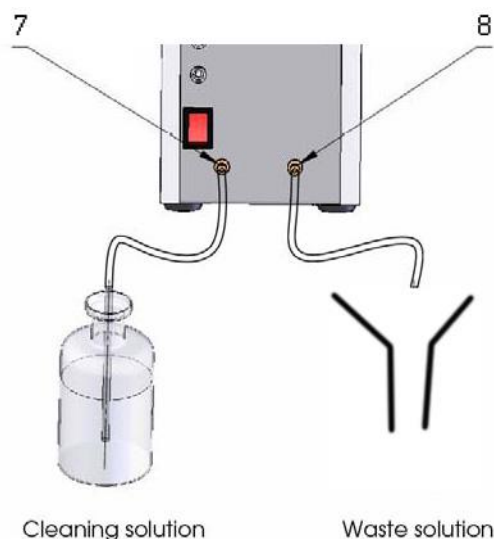

Pay attention to the pipes in both reservoirs. The pipe in the reservoir with the cleaning solution has to be well dipped in the cleaning solution while the pipe in the reservoir with the already used samples and cleaning solution **MUST NOT** be dipped in the liquid.

CHAPTER THREE

3

Samples preparation

In order that most accurate results are obtained it is important that the milk be kept for 2 hours after milking and stirred well before being used for sample material. A good way to stir up the milk is to pour it several times out of one vessel into another and back. Before analysis the samples have to be filtered in order to be free from foreign fragments. Milk samples should be 5-35 °C. Full cream samples containing fat over 10% should be heated up to 42-43 °C and then cooled to 25-30 °C. If the sample temperature is over 36 °C the message “Sample overheated” will appear on the display. Use milk samples only once and do not return it to the vessel. Samples can be kept for a maximum of 2 days if they are stored at a temperature not exceeding 5 °C.

Milk stirring

It is a very important condition for receiving exact results. Before taking samples from big vessels the milk (fresh or thermally treated, whole-milk or whipped) has to be well stirred for no less than 5 min., by vertical and circular slow movements. Mixing spoon with long handle is used, allowing the lowest layers of the liquid to be reached. The milk in the milk-cans is stirred 5 to 8 times from the surface to the bottom and reverse with slow circular movements.

Sample preservation

The vessels where the samples will be put have to be clean, dry, glass, metal or from other suitable material, to be tightly closed with rubber or other stopples. The stopples not to absorb water and fat and not to influence the analyses sample content.

In summer the sample fills up to the top the vessel, but in winter – at least 3/4 from the vessel's volume. Each sample for analyses has to be labeled and described in a way not allowing to be mixed up.

The samples are stored in conditions, assuring temperature, corresponding to the requirements for storing such kind of product (advisable – 1 °C).

If there is a need of longer sample storing they have to be preserved; the most commonly used preservative is potassium bichromate (K₂Cr₂O₇) - 1 g for 1 000 ml. The samples have to be stored in a cold and dark place after the preservation. Have in mind that during the analyses the results for SNF% will be increased with 0,1 %. After adding the preservative the sample has to be well stirred.

Preparing the samples for analyses

Milk – raw and thermally treated

When examining samples taken immediately before analyses and shortly stored, the milk is poured several times from vessel to vessel in order to distribute the fat content uniformly. To avoid foam formation or separation of milk fat, the samples have to be carefully poured using the walls of the vessels, as they are tilted slightly. For a better mixing the sample it has to be poured at least 3 times. When needed the same is tempered to the temperature within the measuring range.

If there is fat stuck on the walls of the vessel and the stopple (when the samples were stored for a long time), the milk has to be slowly heated up to 35-40 °C. At the same time it has to be slowly shaken. The cream, stuck to the walls of the vessel is removed. The sample is poured several times and is cooled down (advisable up to 20°C).



If there is separated liquefied fat or white particles with irregular form on the vessel's walls reliable results could not be expected.



Do not make analyses if the acidity of the milk is more than 17°T

CHAPTER FOUR

4

Working description

IN THIS CHAPTER

- ❑ Preparing the device
 - ❑ Measuring samples
 - ❑ Corrections
-

PREPARING THE DEVICE

1. Place the device on a horizontal and stable surface.
Caution: Any sources of hot or cold air can influence the accuracy of the measurements.
2. Connect the power cord 12V DC to the power socket on the rear panel of the unit and plug it into the electrical outlet (the outlet has to be grounded, see “**Important Safety Instructions**”).
3. Turn ON the **POWER** switch and MILKOTESTER MASTER will be ready for use. Before proceeding with using the unit, please read and follow the rest of the instructions in this chapter!

Powering by an external 12V DC power source

Milk analyzer MASTER can be used in places where no regular electrical supply is available, MILKOTESTER MASTER can be powered by your car battery or other 12V DC external power sources.

Milk analyzer MASTER has provided a cable suitable for this purpose. To use this option, follow the procedure described below:

1. Unplug the 12V DC power cable from the socket on the rear panel of the unit and then from the electrical outlet.
2. Connect the supplied power cord 12V DC to the **Power-in socket 12V DC** socket on the rear panel of the unit and plug the other end of the cable into the electrical lighter socket inside your vehicle.
3. The device will be turned on immediately. After starting the unit goes into system check service menu and will be ready for analyses in about 5 minutes.

NOTE:

If the unit does not start up after it is connected to the power source, check the fuse inside the connector plugged into the electrical lighter socket.

4.2 MEASURING SAMPLES

After MILKOTESTER MASTER is turned ON from the **POWER** switch, the display reads first:

<p>Milk Analyzer MASTER Please Wait System prepare</p>

Followed by:

<p>>Cow Milk Sheep Milk UHT Milk 12:00 01/01/17</p>
--

You can choose among three types of milk at a time, (upon user's request the device can be calibrated for any other types of milk).

Place the cup with the milk sample. Place a second milk sample under the pH probe (the automatic service menu for pH measurement must be turned on). When you choose the desired type you use the ↑↓ (UP and DOWN) arrow buttons, and then press ENTER to activate analyzing.

The following text will appear:

Measuring... Cow milk Temp. 20 C Please Wait...
--

In about 60sec. the results of analyzing will appear on the display as follows:

F=xx.xx	P=xx.xx
S=xx.xx	L=xx.xx
D=xx.xx	SI=xx.xx
Fp- x.xxx	W=xx.xx

Where:

F is for Fat

S is for Solids-Non-Fat (SNF)

D is for Density

Fp is for Freezing point

P is for Protein

L is for Lactose

SI is for Salts

W is for Added water.

In 10 seconds you can check the result of the pH sample by pressing the



Down button. (active only on request)

Page1

F=xx.xx	P=xx.xx
S=xx.xx	L=xx.xx
D=xx.xx	SI=xx.xx
Fp=x.xxx	W=xx.xx

The results will be printed immediately after they are ready.

By choosing the ENTER button you can start measuring anew.

Page2

Temp. xx.xx pH = xx.xx Co = xx.xx
--

By choosing the EXIT button you can start from the very beginning and choose to analyze another type of milk.

When finished analyzing the instrument issues a beep sound, returns the analyzed sample material back into the cup, and the values of all measured components appear on the display. If the unit is connected to the printer all results will be automatically printed out.

At this point the sample cup can be removed from under the pipette. The instrument will continue to show the measured values until a new analysis is initiated.

WARNING!

Make sure that the instrument is at rest during analysis. Any shaking of the device will cause inaccurate results.

NOTE:

Due to the possible presence of water inside the flow system left from the last flushing procedure, we recommend that you do not take into account the first analysis after flushing if they appear inaccurate. To prevent or reduce this inaccuracy due to water in the system, please refer to chapter "Cleaning and Maintenance".

To access the menu, press the MENU button. The range of functions is grouped into submenus. Scroll through the menu to select the one that you need and then select the settings you need to make. Press ENTER to activate them. Press EXIT to keep the previous settings.

4.3 MAKING CORRECTIONS

In the process of work with the analyzer there is a possibility the results to start differing between the data for some of the measuring parameters when measured with the milk analyzer and the corresponding reference method of analyses (Gerber for fat, Kjeldahl for proteins etc). In order to establish the possible discrepancy and to correct the readings of the milk analyzer do the following:

Taking samples and preparation of samples for checking the accuracy of the milk analyzer, making corrections and recalibration

This is a basic moment for the correct checking the accuracy of the analyzer and for making correct and precise correction and calibration. It is accomplished according Appendix Taking and preparation of samples for checking correctness of the milk analyzer, making corrections and recalibration.

Determination the type of the discrepancy:

Making measurements

Make measurements with different samples (not less than 3) with known values of a separate parameter (for example fat content), determined by the known reference methods of analyses (for example Gerber's method for determination of fat content). For more accuracy it is recommended among these samples to be also such with values, close to the lowest and highest bounds for the measured parameters.

Make 5-time measurement for each of the samples. Calculate the average value for each sample parameter, without taking into consideration the first measurement for each sample.

Analyzing the measurement results

Make comparison between the values of the parameter from the reference sample and measured with the analyzer. Make analyses of the difference received.

If the received differences are relatively constant value for samples with different content of the analyzed parameter, it is necessary to make correction.

For example

M% of the reference samples:	2,20	3,00	3,80	4,60	5,20
M% average when measuring with the analyzer:	2,38	3,17	4,01	4,79	5,42
Difference:	0,18	0,17	0,21	0,19	0,22

Conclusion: the difference is relatively constant value and correction is possible to be done with – 0,2 %

If the differences are not a constant value it is necessary recalibration to be done.

For example.

M% of the reference samples:	2,20	3,00	3,80	4,60	5,20
M% when measured with the analyzer:	2,02	2,93	3,76	4,75	5,44
Difference:	-0,18	-0,07	-0,04	0,15	0,24

Conclusion: It is obvious that the difference is variable value and recalibration has to be done.

MENU

To select Service menu, System or Settings use the ↑↓ (up and down) arrows and press ENTER.

Service menu System Settings Memory
--

MENU > Service menu

Enter password 00000

Default password is 00000.

Correction Calibration Security Res. d. point
--

Correction

Example:

MENU > Service menu > Correction > Cow milk > Fat.

In Submenu *Service menu* Use the ↑↓ (up and down) arrows and press ENTER to select Correction, Calibration, Back up or Restore.

If you choose correction and press ENTER, then use the ↑↓ (up and down) arrows and press ENTER to select the type of milk.

Cow Milk Sheep Milk UHT Milk Temperature

After choosing the type of milk use the ↑↓ (up and down) arrows and press ENTER to choose a component for correction (mind that there are 2 (two) pages of components thus scroll up and down).

Fat SNF Density
--

Protein Lactose Salts Water
--

Press the ↑↓ (up and down) arrows to correct the value with 0.01.

Correction Of Fat 0.01
--

Press ENTER to validate the correction or EXIT to keep the previous value.

CHAPTER FIVE

5

Determination of the milk and calibration

IN THIS CHAPTER

- ❑ Representative samples from milk and other milk derivatives for calibration
 - ❑ General
 - ❑ Necessary quality parameters values determination
 - ❑ Advisable scheme for independently determination the content of the milk
 - ❑ Calibration
-

5.1 Representative samples from milk and other milk derivatives for milk analyzer's calibration

5.1.1. General

The samples used for analyzer's calibration have to be representative for the corresponding milk type and have to be with known quality parameters: fat in percentage, SNF in percentage, density, lactose in percentage, total protein in percentage and salts in percentage. Changes in the analyzed parameters in the samples, have, if possible, to cover the whole measuring range – i.e. used samples to be with low and high content of the analyzed components.

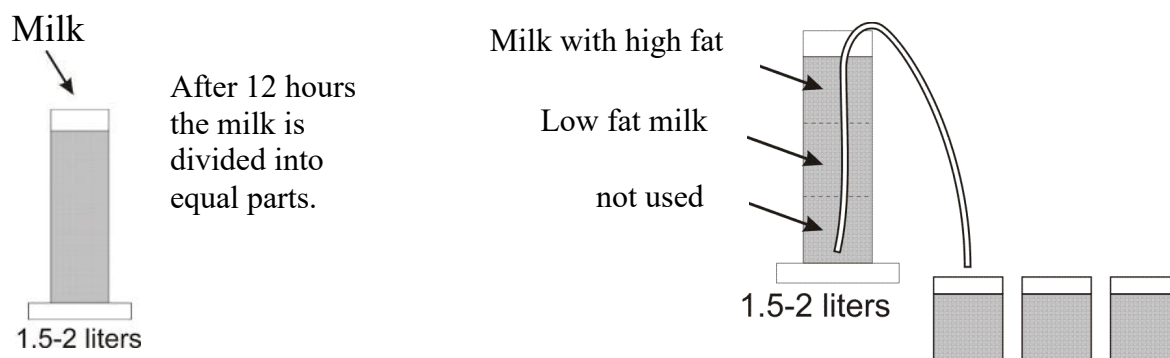

Milk with high and low fat is used for auto calibration of milk analyzer.

The exact value of the parameters is decisive for correct and accurate calibration, because if the parameters are not set correctly during calibration the same parameter will not be measured correctly.

5.1.2. Necessary quality parameters values determination

For more precise determination of above listed quality parameters of the milk and its derivatives is advisable they to be examined in an authorized laboratories, using the corresponding arbitration methods for this purpose.

5.1.2.1. Laboratory methods

5.1.2.1.1 Determination of fat content

Determination of fat content in the milk and its derivatives (cream, whey, buttered milk) is one of the most important analyses in the dairy production and milk processing. According this parameter the payment schemes are made and it is observed from the point of view correct production process and the basic economy balances are made with its help.

A/ Röse-Gottlieb method

The fat content is determined using the gravimetric method, fat extraction from ammonia-alcohol milk solution using diethyl and petroleum ether, evaporation of the solvent and weighting the residuum.

B/ Gerber method

The proteins in the milk and dairy products are dissolved with sulphuric acid with definite concentration in butyrometer and the fat is separated under the influence of amyl alcohol, heating and centrifuging in a form of dense, transparent layer. The volume of this layer is measured in the divided part of the butyrometer.

This is quick, easy method with sufficient accuracy. We recommend it for usage. For more detailed description see Appendix Methods.

5.1.2.1.2. Milk density determination

Density = Mass/Volume

Generally, the density for cow milk at 20°C is about 1.030 kg/l

Density results appear on display (minus 1000). So, when the density is 1.030 kg/l, on the milk analyzer display is 30.

This applies on the **COW, SHEEP, BUFFALO, GOAT** and **UHT** milk.

The formula is different for **CREAM**. The results appear on display (minus 980), so when the density is 32 on display, actually is 1.012 kg/l

A/ With pycnometer and Mor-Vestval scales

This is the most exact method for determination of milk and its derivatives' density.

B/ With aerometer (lacto-density-meter)

Compared with the above method this is quick and easy readable with satisfactory accuracy. We recommend it. For more detailed description see Appendix Methods.

During the lactation period and under the influence of different zoo engineering factors the density of the different milk kinds varies in the following bounds:

Milk kind	Minimum	Maximum	Average
Cow	1,027	1,033	1,030
Buffalo	1,026	1,032	1,029
Goat	1,027	1,033	1,030
Sheep	1,031	1,040	1,034

5.1.2.1.3. Determination of total proteins

A/ Kjeldahl method

Heating with concentrated sulphuric acid in the presence of catalyst mineralizes a definite volume of the milk sample. The liberated ammonium combines with the sulphuric acid and forms ammonium sulphate. After adding surplus soda caustic ammonium is liberated. When distilled it combines with the boric acid.

The quantity of the combined ammonium is determined by titration with acid with determined titer. Combined with the ammonium acid the initial nitrogen content is determined, and also the proteins in the milk.

B/ Titration with formalin

Formalin, added to the milk, combines with the amino group in the protein's molecule and forms methyl groups, which have no alkaline reaction. Milk acidity increases by the liberated carboxylic groups, which are titrated with soda caustic solution. The used volume soda caustic is proportional to the protein content in the milk.

5.1.2.1.4. Determination of casein content in the milk

A/ Kjeldahl method

The total nitrogen content in the milk is determined. Casein is precipitated with acetic acid (acetate buffer) and is filtrated. The content of nitrogen in the filtrate is determined. Casein content is the difference between the two results for nitrogen using the Kjeldahl's method.

B/ Titration with formalin

More details for this method – see Appendix Methods.

5.1.2.1.5. Determination of salts in milk.

For the salts in milk and its derivatives is judged by its ashes content. Milk dries, becomes carbonized and turns to ashes till constant mass. The ashes received are calculated in percentage.

5.1.2.1.6. Determination of solids in milk

Solids describe the content of fats, proteins, carbohydrates and salts. Its value may be used for determination of each of these parameters in case of known other values.

Salts are determined by drying till constant mass – see Appendix Methods.

5.1.2.2. Express methods by using another milk analyzers

It is possible another device to be used for determination of some of the quality parameters of milk and its derivatives samples, intended for calibration, but it has to be noted that it is possible incorrect values to be received, that's why it is necessary to be completely sure in the accuracy of their readings.

Usage of other milk analyzers based on the infrared measurement principle.

By using it the fat, lactose and protein content may be determined. Problem may arise with determination of salts and SNF. This is due to the impossibility of the infrared method to determine the solids and in order to receive the solids in the sample their meaning is accepted as a constant.

5.1.2.3. Determination of some of the parameters by formulas

There is dependence between the different parameters in milk and its density, which may be expressed with mathematical equation. On that base different formulas, tested and confirmed by the classical laboratory methods for analyses, are developed. We recommend the following:

5.1.2.3.1. SNF determination.

For determination of SNF the correlation dependence exists between the milk's density, fat and SNF in the milk. When the density and the fat are known, the SNF can be calculated.

There are several formulas with different applicability.

A/ When the solids and fat are known
SNF is calculated by subtracting the fat percentage from the solids.
SNF = Total Solids – F (%))

where

Total Solids in (%),

F – fat content in (%),

This formula is used for determination of SNF in whey, buttermilk, and cream.

B/ Known quantity of fat and density (most commonly used method when maximum accuracy is needed).

We recommend the following formula:

$$SNF = \frac{0,075 * F\% + 100 - 100 / density}{0,378}$$

This is a universal formula and actual for milk of almost all kind of cows and sheep all over the world.

5.1.2.3.2. Determination of lactose content

We recommend the following formulas:

A/ for cow milk

$$\text{Lact.} = \text{SNF} * 0,55 (\%)$$

where

SNF – content of SNF in percentages (%),

0,55 – constant coefficient.

B/ for sheep milk

$$\text{Lact.} = \text{SNF} * 0,45 (\%)$$

where

SNF –solids-non-fat content in percentages (%),

0,45 – constant coefficient.



This is an actual coefficient for sheep breeds on the territory of the Balkan Peninsula.

5.1.2.3.3. Determination of salts content

We recommend using the following formulas:

A/ for cow milk

$$\text{Salts} = \text{SNF} * 0,083 (\%)$$

where

SNF – solids-non-fat content in percentages (%),

0,083 – constant coefficient.

B/ for sheep milk

$$\text{Salts} = \text{SNF} * 0,075 (\%)$$

where

SNF – solids-non-fat content n percentages (%),

0,075 – constant coefficient.



This is an actual coefficient for sheep breeds on the territory of the Balkan Peninsula.

5.1.2.3.4. Determination of total proteins content

We recommend using the following formulas:

A/ for cow milk

$$\text{Protein} = \text{SNF} * 0,367 (\%)$$

where

SNF - solids-non-fat content in percentages (%),

0,367 – constant coefficient.

B/ for sheep milk

$$\text{Protein} = \text{SNF} * 0,475 (\%)$$

where

SNF – solids-non-fat content in percentages (%),

0,475 - constant coefficient.



This is an actual coefficient for sheep breeds on the territory of the Balkan Peninsula

5.1.3. Advisable scheme for independently determination the content of different parameters in milk and its derivatives

When is not possible to use the help of authorized laboratories and above mentioned milk analyzers we recommend you to follow the scheme:

5.1.3.1. For cow milk (whole milk, low fat, skimmed milk) and UHT milk

Determination of fat content – Gerber’s method, described in Appendix Methods.

Density determination – using aerometer, described in Appendix Methods.

SNF determination – by formula – p. 3.2.3.1.B

Determination of Lactose content – by formula – p.3.2.3.2.A

Determination of salts content – by formula – p. 3.2.3.3.A

Total protein content determination – by formula – p. 3.2.3.4.A

Example: Determination of the quality parameters for two samples cow milk (low fat and high fat), obtained and prepared according p. 2.3.1 and 2.4.1.

First – determine the fat content in the samples, using the Gerber’s method (p.3.2.)

Suppose that for the first sample the result is 2,0 %F, for the second – 5,9 %F.

Second – determine the milk density, using aerometer (p.3.1.)

Suppose that the results are 1,0316 for the first sample and 1,0274 for the second

Third – Calculate the SNF content using the formula (p.3.2.3.1.B)

$$SNF = \frac{0,075 * 2,0 + 100 - 100 / 1,0316}{0,378} = 8,50\%$$

$$SNF = \frac{0,075 * 5,9 + 100 - 100 / 1,0274}{0,378} = 8,23\%$$

Fourth – determine the lactose content by the formula (p.3.2.3.2.A)

$$\text{Lact.} = SNF * 0,55 = 8,50 * 0,55 = 4,67 \%$$

$$\text{Lact.} = SNF * 0,55 = 8,23 * 0,55 = 4,53 \%$$

Fifth – determine the solids content by formula (p.3.2.3.3.A /

$$\text{Salts} = SNF * 0,083 = 8,50 * 0,083 = 0,71 \%$$

$$\text{Salts} = SNF * 0,083 = 8,23 * 0,083 = 0,68 \%$$

Sixth – determine the total protein content by formula (p.3.2.3.4.A)

$$\text{Proteins} = \text{SNF} * 0,367 = 8.50 * 0.367 = 3.12 \%$$

$$\text{Proteins} = \text{SNF} * 0,367 = 8.23 * 0.367 = 3.02 \%$$

So, when calibrating the milk analyzer we'll use samples with the following parameters:

	<u>I st sample</u> (low fat)	<u>II nd sample</u> (high fat)
milk fat	2,00	5,90
SNF	8,50	8,23
density	1,0316	1,0274
lactose	4,67	4,53
salts	0,71	0,68
proteins	3,12	3,02

5.1.3.2. For sheep milk

Determination of fat content – Gerber's method, described in Methods p. 3.4.

Density determination – using aerometer, described in Methods p. 3.3.

SNF determination – by formula – p. 3.2.3.1.B

Determination of Lactose content – by formula – p. 3.2.3.2.A

Determination of solids/salts content – by formula – p. 3.2.3.3.A

Total protein content determination – by formula – p. 3.2.3.4.A

Example: Determination of the quality parameters for two samples sheep milk (low fat and high fat), obtained and prepared according p. 2.3.1 and 2.4.1.

First – determine the fat content in the samples, using the Gerber's method (p.3.2.)

Suppose that for the first sample the result is 5,6 %M, for the second – 9,8 %M.

Second – determine the milk density, using aerometer (p.3.1.)

Suppose that the results are 1,0352 for the first sample and 1,0300 for the second

Third – Calculate the SNF content using the formula (p.3.2.3.1.B)

$$SNF = \frac{0,075 * 5,6 + 100 - 100 / 1,0352}{0,378} = 10,11\% \quad SNF = \frac{0,075 * 9,8 + 100 - 100 / 1,0300}{0,378} = 9,65\%$$

Fourth – determine the lactose content by the formula (p.3.2.3.2.A)

$$\text{Lact.} = \text{SNF} * 0,45 = 10,11 * 0,45 = 4,55 \%$$

$$\text{Lact.} = \text{SNF} * 0,45 = 9,65 * 0,45 = 4,34 \%$$

Fifth – determine the solids content by formula (p.3.2.3.3.A /

$$\text{Solids} = \text{SNF} * 0,075 = 10,11 * 0,075 = 0,76 \%$$

$$\text{Solids.} = \text{SNF} * 0,075 = 9,65 * 0,075 = 0,72 \%$$

Sixth – determine the total protein content by formula (p.3.2.3.4.A)

$$\text{Proteins} = \text{SNF} * 0,475 = 10,11 * 0,475 = 4,80 \%$$

$$\text{Proteins} = \text{SNF} * 0,475 = 9,65 * 0,475 = 4,58 \%$$

So, when calibrating the milk analyzer we'll use samples with the following parameters:

	<u>I st sample</u> (low fat)	<u>II nd sample</u> (high fat)
milk fat	5,60	9,80
SNF	10,11	9,65
density	1,0352	1,0300
lactose	4,55	4,34
salts	0,76	0,72
proteins	4,80	4,58

5.1.3.3. For whey, buttermilk and cream

Determination of fat content – Gerber's method, described in Methods p. 3.4.

Density determination – using aerometer, described in Methods p. 3.3.

SNF determination – using drying - p. 3.3. and formula – p. 3.2.3.1.A

5.2. Calibration:

MENU > Service menu > Calibration.

In order to perform calibration of the device for a certain type of milk /for example – cow milk/. You need two samples of milk with known values of their parameters – one with comparatively high percentage of Fat and one with comparatively low percentage of Fat.

After pressing ENTER on the display appears:

Cow milk
Sheep milk
UHT milk
Backup Calibration

Restore Calibration
Sensor RESET

Use the ↑↓ (up and down) arrows and press ENTER to select the type of milk. The following text will appear on the display:

Set High sample
FAT=x.xx
SNF=x.xx
DEN=x.xx

Set High sample
PRO=x.xx
LAC=x.xx
SAL=x.xx

Use the ↑↓ (up and down) arrows and press ENTER to select a parameter. Then the cursor will mark the place to enter a known value. Use the ↑↓ (up and down) arrows to set the desired figure and press ENTER to confirm. Then the cursor goes to the figure to the right. Use the same procedure to enter the second and third figure. After confirmation of the last figure the cursor goes to the next parameter for entering new values (mind that there are 2 (two) pages of components thus scroll up and down).

By confirming the last figure of the last parameter the following text appears on the display:

Set Low sample
FAT=x.xx
SNF=x.xx
DEN=x.xx

And then

**Set Low sample
PRO=x.xx
LAC=x.xx
SAL=x.xx**

By performing the procedure described above enter the known values of the parameters of the milk with low percentage of Fat. After confirming the last figure of the last parameter by pressing ENTER the following text appears on the display:

**Put sample
High Milk
1/5 times
and Press ENTER**

The sample of milk with high Fat must be measured 5 consecutive times. Put the first cup with the sample and press ENTER. After measurement the following text appears on the display:

**Put Sample
High Milk
2/5 times
and Press ENTER**

Follow the procedure until the 5th measurement. After performing the last measurement the following text appears on the display:

**Put Sample
Low Milk
1/5 times
and Press ENTER**

The sample of milk with low Fat must be measured 5 consecutive times. Put the first cup with the sample and press ENTER. After measurement the following text appears on the display:

**Put Sample
Low Milk
2/5 times
and Press ENTER**

Follow the procedure until the 5th measurement. After performing the last measurement the following text appears on the display:

**Put Sample
Water
1/5 times
and Press ENTER**

Follow the described above procedure. After the end of the 5th measurement the calibration procedure is complete.

Please note:

Before each sample measurement stir the milk by pouring it from one vessel to another.

The temperature of the samples should be in the range of 15 to 25 degrees.

Before starting calibration it is recommendable to back up the parameters of the existing calibration:

MENU > Service menu > Calibration > Back up

**Cow – calibr. 1
Sheep – calibr.2
UHT – Calibr. 3**

Choose the type of milk calibration for back up and press ENTER

In case of unsuccessful calibration / electricity cut, temperature range, etc / choose Restore from the MENU to validate the last backed up calibration and press ENTER.

MENU > Service menu > Calibration > Restore

**Cow – calibr. 1
Sheep – calibr.2
UHT – Calibr. 3**

Choose the type of milk calibration for Restore and press ENTER

MENU > Service menu > Calibration>Sensor reset



Use only if the sensor is changed

If you use this option, you will need a sample with stagnant water (calm and without air bubbles) with recommended room temperature.

*Read the manual for change of the sensor

MENU > Service menu > Security

**Type of results
Limited measurement.
Edit password**

MENU > Service menu > Security>Limited measurement.

**200 measurements
400 measurements
600 measurements
OFF counter**

Limits the number of measurements (suitable for samples)

MENU > Service menu > Security>Edit password

**ON password
OFF password
Change password**

MENU > Service menu >Res d point

**XX.X
XX.XX**

CHAPTER SIX

6

System and settings

IN THIS CHAPTER

- System and settings
 - Measurement of pH
 - Method of determination
 - Conductivity calibration
-

6.1. System, Settings and Memory

MENU > System

<p>System Info Language Time and Date PC connection</p> <hr/> <p>Printer En/Dis</p>
--

Choose Options and press ENTER.

MENU > System > System info.

Choose System info, Language or Time and Date, and press ENTER.

Milk analyzer
MASTER Version:
Count: ...
SN: XXXXX

MENU > System > Language.

Language:

English
Spanish

MENU > System > Time and Date

Time and date:

Set time
Set date

MENU > System > PC connection
It is used for sending data to PC

MENU > System > Printer En/Dis

Printer On
Printer Off

It is used to turn the printer on and off

The printer will automatically show result after each measurement if it's ON.

MENU > Settings

Choose *Settings* and press ENTER.

Set Fr. Point Set pH Set thermometer Conductivity ----- Cleaning cycles Fast start
--

MENU > Settings > Set Fr. Point.

Set f. Point Cal.1 Set f. Point Cal.2 Set f. Point Cal.3

Choose Set Fr. point and press ENTER.

Use ↑↓ (Up and Down) arrows to choose a type of milk and press ENTER. The following text appears on the display:

Set Fr. Point 0,540 Press ENTER To Set

Use ↑↓ (Up and Down) arrows to enter the new value and Press ENTER to confirm. After dialing the last symbol press ENTER to confirm the new value.

6.2. Measurement of pH

MENU > Settings > Set pH

(active only on request)

Set pH:

pH calibration pH mode

The pH scale

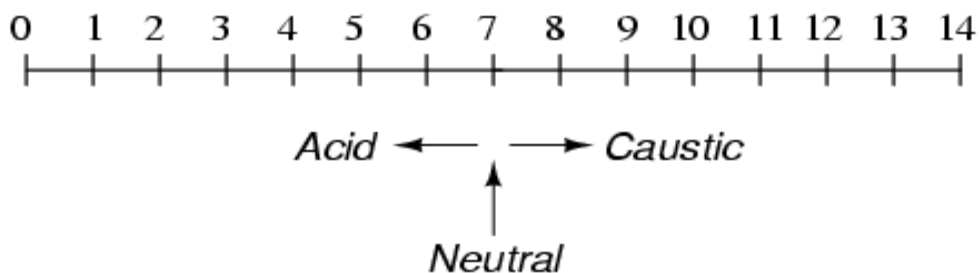

In the next table you can see the pH error based on the temperature, which is function of the pH measurement and the temperature itself. In pH 7 there is no temperature error and also there is no error when the temperature is stable. The more difference of the temperature from the surrounding environment – the more pH deviates from 7 and the bigger is the pH error.

°C	°F	2	3	4	5	6	pH7	8	9	10	11	12
5	41	+0,30	+0,24	+0,18	+0,12	+0,06	0	+0,06	+0,12	+0,18	+0,24	+0,30
15	59	+0,15	+0,12	+0,09	+0,06	+0,03	0	+0,03	+0,06	+0,09	+0,12	+0,15
25	77	0	0	0	0	0	0	0	0	0	0	0
35	95	-0,15	-0,12	-0,09	-0,06	-0,03	0	-0,03	-0,06	-0,09	-0,12	-0,15
45	113	-0,30	-0,24	-0,18	-0,12	-0,06	0	-0,06	-0,12	-0,18	-0,24	-0,30
55	131	-0,45	-0,36	-0,27	-0,18	-0,09	0	-0,09	-0,18	-0,27	-0,36	-0,45
65	149	-0,60	-0,48	-0,36	-0,24	-0,12	0	-0,12	-0,24	-0,36	-0,48	-0,60
75	167	-0,75	-0,60	-0,45	-0,30	-0,15	0	-0,15	-0,30	-0,45	-0,60	-0,75
85	185	-0,90	-0,72	-0,54	-0,36	-0,18	0	-0,18	-0,36	-0,54	-0,72	-0,90

Temperature effects on the value of pH buffers

T (°C)	pH		
0	4.01	7.12	9.52
10	4.00	7.06	9.38
20	4.00	7.02	9.26
25	4.01	7.00	9.21
30	4.01	6.99	9.16
40	4.03	6.97	9.06
50	4.06	6.97	8.99
60	4.10	6.98	8.93
70	4.16	7.00	8.88
80	4.22	7.04	8.83
90	4.30	7.09	8.79

MENU > Settings > Set pH > pH Calibration

In order to calibrate the device you will need two buffer solutions with known values, for example – one with value of pH 3 /low value/ and the other – pH 7 /high value/.

After choosing Set pH the following text will appear on the display

**Set
pH low buffer:
x.xx**

Remove the protective cup of the electrode.

Dip the electrode into the low value buffer solution and make sure that the junction zone of the electrode is at least at 30 mm below the surface of the buffer solution and leave it at rest. Now you have to enter the known value of the “low” buffer solution. Use ↑↓ (Up and Down) arrows to enter the new value and Press ENTER to confirm. After dialing the last symbol press ENTER to confirm the new value.

The following text will appear on the display:

**Setting
Ref. Value: xxxxx**

Wait until the electrode and the buffer stabilize /the reference value should change the least possible/. Press ENTER to set the value.

The following text will appear on the display:

**Set
pH high buffer:
x.xx**

Dip the electrode into the high value buffer solution and make sure that the junction zone of the electrode is at least at 30 mm below the surface of the buffer solution and leave it at rest. Now you have to enter the known value of the “high” buffer solution. Use ↑↓ (Up and *Down*) arrows to enter the new value and Press ENTER to confirm. After dialing the last symbol press ENTER to confirm the new value.

The following text will appear on the display:

<p style="text-align: center;">Setting</p> <p>Ref. Value: xxxxx</p>

Wait until the electrode and the buffer stabilize /the reference value should change the least possible/. Press ENTER to set the value

Please note:

The pH electrode must be calibrated on a regular base in order to obtain high accuracy results of the measurement.

For calibration use buffer solutions with values as close as possible to the pH values of the milk samples.

After each measurement of pH rinse the tip of the electrode with de- ionized water.

After each measurement or calibration put on the protective cup of the electrode.

The pH electrode is fragile and must be handled with care.

MENU > Settings > Set pH > pH mode

<p>pH calibration</p> <p>pH mode</p>
--

The milk analyzer has two service menus of work – manual and automatic. They are selected from *MENU > Settings > set pH > pH service menu* Choose *pH service menu* and press ENTER.

Auto pH measure
Manual pH measure

Under the manual service menu, the milk sample is put under the pH probe, then you press the pH button and the measurement will last without interruption (until the pH button is pressed again). In order to measure pH the device must be in a working condition.

Measurement of pH is not possible when the device is in the following service menu:

MEASURING...
Please Wait

In this service menu the device is measuring all the other components.

To start measurement of pH press pH button. The milk analyzer now is operating as a pH meter. The following text will appear on the display:

pH result:
X.XX

Press the EXIT button to stop measurement of pH and enter the main menu:

Cow Milk
Sheep Milk
UHT Milk

In automatic pH mode, you have to put the electrode on the top of the analyzer. There is protective cap with white top in it.

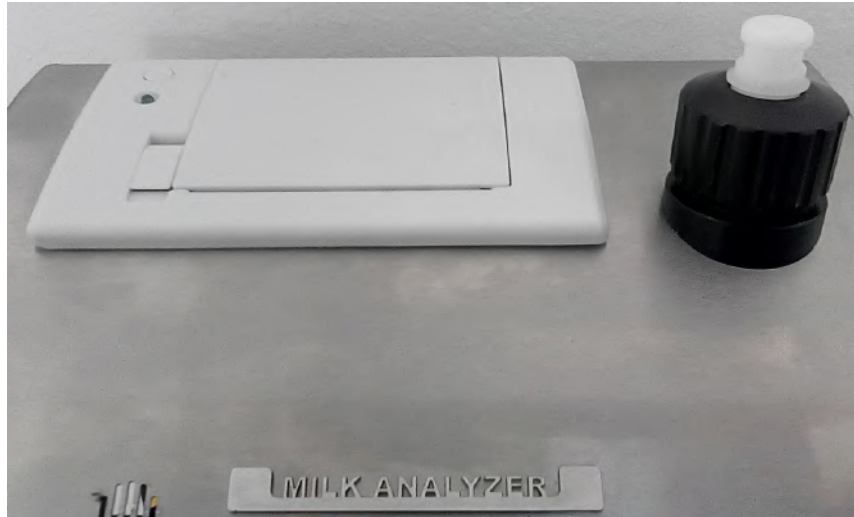

Unscrew the black cap one turn, but do not remove it.

Then pull out the white gasket in the center.

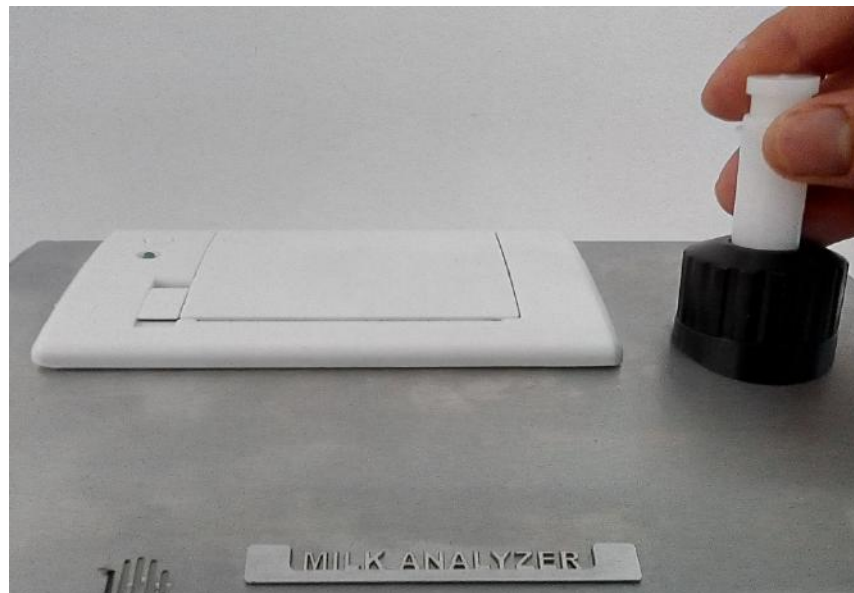

After that, put in the pH electrode and tighten the black protective cap:

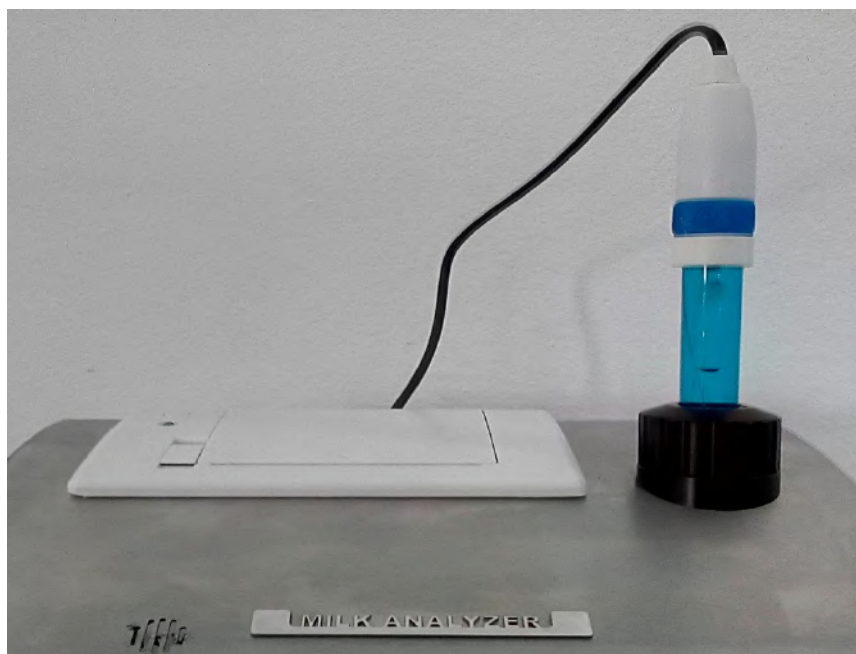

Connect the electrode to the pH connector on the rear panel of the analyzer. Now when you start measuring milk, the device will automatically measure pH of the milk sample.

MENU > Settings > Set Thermometer

Press ENTER and the following text will appear on the display:

**Put probe 15°C
and press ENTER**

Put a sample of water with temperature 15°C and press ENTER
The following text will appear on the display:

**Put probe 25°C
and press ENTER**

Repeat the procedure with a sample of 25°C

6.3. Measurement of Conductivity

MENU > Settings > Conductivity
(active only on request)

**Calibr.Co Meter
ON/OFF Co Meter**

6.4. Method of determination.

Conductivity (or Electrolytic Conductivity) is defined as the ability of a substance to conduct electrical current. It is the reciprocal of the resistance.

In a healthy animal*, the mean value of electric conductivity is:

Milk type	Conductivity values
Cow milk	between 4 to 6,5 mS/cm (25°C);
Sheep milk	between 3 to 5,5 mS/cm (25°C);
Buffalo	between 2,5 to 5,5 mS/cm (25°C);

*These values depend on the geographical region, the breed and on other factors.

Milk conductivity changes on the concentration of ions in the milk:

6.5. Conductivity calibration

Menu > Settings > Conductivity > Calibration Co meter

Following message is displayed:

Put sample 5.0mS/cm

1/5 times
And press Enter

Serves for conductivity measuring system calibration. Clean the analyzer before starting conductivity measurement. You need a standard buffer with conductivity 5.0[mS/cm], with temperature 25C.

Menu > Settings > Conductivity > ON/OFF Co Meter

ON Co Meter OFF Co Meter

Menu > Settings > Cleaning cycles

You can determine cycles for the cleaning procedure.

MENU > Settings >Fast start

Enable Disable

It starts the measurement irrespective of the ambient temperature (used in hot weather)

IT IS RECOMMENDED TO USE THIS OPTION WHEN THE DEVICE WORKS AT MORE THAN 35 C IN THE ROOM.

Memory

MENU > Memory >Memory to print

Last analysis Last 5 analysis Last 10 analysis All analysis
--

Sends the recorded results to printer or PC

MENU >Memory >Clear memory

Delete all recorded results

MENU >Memory > Auto save ON/OFF

ON Rec. measur. OFF Rec. measur.

CHAPTER SEVEN

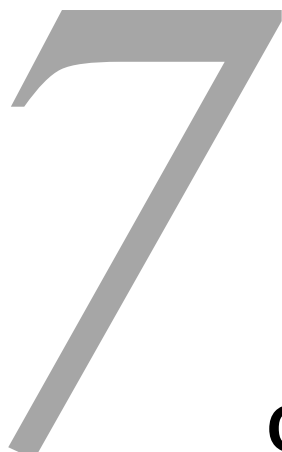

Cleaning and maintenance

IN THIS CHAPTER

- ❑ Routine cleaning
 - ❑ Complete flushing
 - ❑ Weekly cleaning
 - ❑ Power OFF
-

For high accuracy and reliability of the device, the following cleaning procedures should be performed on due times.

7.1. Routine cleaning

When the interval between 2 consecutive measurement analyses is more than 30 minutes or a considerable number of measurements have been performed the device begins to issue continuing beep sounds. At the same time the message **Cleaning needed** appears on the display. Please carry out the following procedure:

1. Fill up a sample cup with clean warm water (45 – 50°C) and place it on the sample shelf under the pipette.
2. Press “clean” to initiate the flushing procedure. The device automatically takes in the necessary amount of water and then returns it back into the cup. This is repeated 5 consecutive times and after that the cup has to be removed from the sample shelf.

After the end of the procedure the device is ready for measurement.

7.2. Complete flushing

At the end of the working day the following procedure should be performed:

The daily cleaning of the milk analyzer is done with cleaning powder “Master Daily”, heated to 50° C, by pressing the button “Clean”. The liquid in the cup must be changed each time until all of the contamination is removed. At the end the system must be washed out with water.

7.3 Weekly cleaning

We recommend that you carry out the following procedure at the end of every week.

The weekly cleaning of the milk analyzer is done with cleaning powder “Master Weekly”, heated to 50° C, by pressing the button “Clean”. The liquid in the cup must be changed each time until all of the contamination is removed. At the end the system must be washed out with water.

7.4 Power OFF

In the end of the day after you finished work with the device and it is already cleaned with Master Daily solution, put sample with clean water and choose from the cleaning menu ‘Power OFF’.

Cleaning > power OFF

Fast cleaning Daily cleaning Weekly cleaning Power OFF

After choosing it, on the screen will appear:

**Put
clear water
and press
ENTER**

After the device suck the water, on the screen appears:

**Please
switch OFF
the milk
analyzer**

Turn OFF the analyzer by hand from the power switch button on the rear panel.

The milk analyzer is switched OFF with water in the system so it will preserve the device clean from drying milk particles until the next working day.

Remember to put empty cup on the milk analyzer when switching it ON, because the water from the system will drain on start.

After that, the device is ready to work.

7.5 Peristaltic pump service

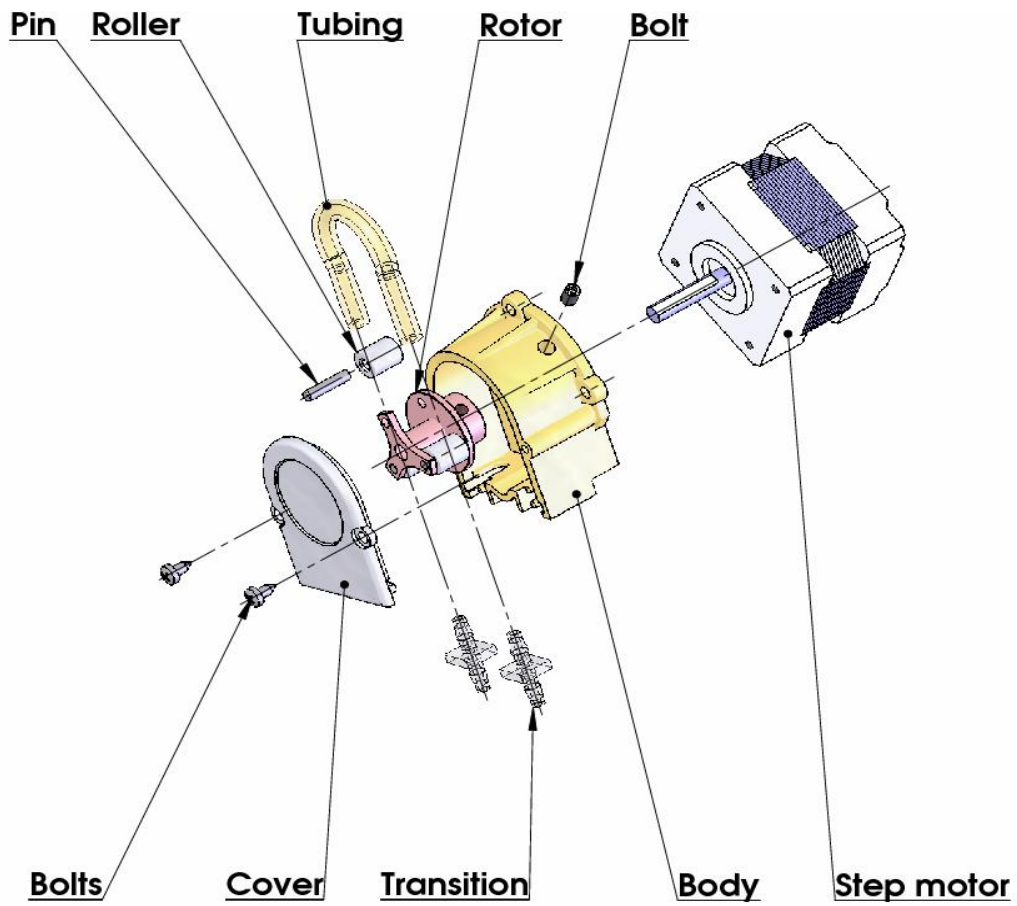

CHAPTER EIGHT

8

Troubleshooting

Error message	Possible problem /cause	Repair/remedy
Error 10 Empty Sensor	Insufficient quantity of the milk sample sucked in the system or air in the sample	<ul style="list-style-type: none"> - Check if there is no air bubbles in the sample. - Check if after starting measurement, milk sample in the sample holder decreases. In other case – there is damage in the suction system.
The sample temperature is high.	Sucked overheated sample	<ul style="list-style-type: none"> - The sample temperature exceeds the maximum permissible sample's temperature.
The temperature of box is high	Analyzer temperature has exceeded acceptable at work.	<ul style="list-style-type: none"> - ENABLE OPTION 'FAST START' (see menu settings – fast start)
Error 11	Fault in sensor	<ul style="list-style-type: none"> - Needs replacement of the sensor. Contact - Milkotester Ltd for - advice and assistance.

CHAPTER NINE

9

Technical specification

1. Measured components:

- Fat
- Solids-Non-Fat (SNF)
- Protein
- Lactose
- Water content
- Temperature (°C)
- Freezing point
- Salts
- Density

2. Ranges of measurement:

Fat	0% - 35%
SNF	3% - 40%
Density *	1000 - 1160 kg/m ³
Proteins	2% - 15%
Lactose	0.01% - 20%
Added water	0 % ÷ 70 %
Sample temperature	5°C - 40°C
Freezing point	-0.4°C to -0.7°C
Salts	0.4% - 1.5%

active only on request:

Conductivity	2-14mS/cm
pH	0-14

* To determine the milk density, add 1000 to the result from the display.
Example: Result = 22; density = 22+1000 =1.022.

3. Accuracy:

Fat	±0.06%
SNF	±0.15%
Density	± 0.3 kg/m ³
Proteins	±0.15%
Lactose	±0.2%
Added Water	±3%
Sample Temperature	±1°C
Freezing point	±0.005°C
Salts	±0.05%
Air temperature	from 10°C to 40°C
Relative humidity	from 30% to 80%
Electrical parameters:	
AC Power supply	95÷250V
DC Power supply	12V

(active only on request)

pH	± 0.05
Conductivity	±0.05mS/cm

4. Dimensions:

150x290x285 mm

5. Weight – 2.8 kg

1. Milk sample volume per 1 measurement: 25 cm³ (=25 ml)

Appendix Freezing point determination

1. Methods for determination.

The milk analyzer determines the freezing point of each sample and the quantity of added water. The milk analyzer does not measure the freezing point, but calculates it from the components it depends on. The basic components in the milk are water, salts, lactose, FAT, proteins, minerals (salts) and acids. The freezing point depends only on the diluted in the milk components and quantity of the solvent (in the milk it is water). The ultrasonic technology allows direct measurement of FAT, proteins, lactose + salts (the soluble components, only influencing the freezing point), and the quantity of the solvent in % is determined by $100\% - \text{total solids \%}$, $\text{total solids} = \text{lactose \%} + \text{FAT \%} + \text{proteins \%} + \text{salts \%} + \text{acids \%}$.

Without understanding the meaning of the freezing point – determined or shown from the milk analyzer added water result easily may lead to a mistake for the value of this parameter.

2. The basic freezing point.

Milk freezes at lower temperature than water. The average freezing point of the raw milk in the most regions is at about $-0,540^{\circ}\text{C}$. The average reading for your region is called “basic” freezing point.

The freezing point of milk is a “physiological constant”. This does not mean that it will not vary. In fact feed, breed, season, time of lactation, climate, whether the sample is taken at the beginning, middle or end of lactation – all these factors will have an effect on the freezing point of the individual sample. This means that there is an average value of all these numbers. The more samples used in obtaining this average, the more reliable it is as a base. Or the basic freezing point is an average of freezing points of milk, taken from many cows. When a laboratory checks a producer, it is only comparing the average of the producer’s cows against a larger area average.

The Health authorities establish the basic freezing point or agriculture departments in some regions, sometimes by universities, separate dairy producers, or their associations. Frequently, tolerances have been established on top of a basic freezing point to allow some variations in the milk as well as device or operator variations.

Without mentioning the basic freezing point, the Association of Official Analytical Chemists now recommends an upper limit freezing point at $-0,525^{\circ}\text{C}$ (2,326 standard deviations above the most recently determined North American average of $-0,5404^{\circ}\text{C}$), below which there will be at 95% confidence that will show 99% of all freezing point determinations on dewatered milk:

“if the freezing point is $-0,525^{\circ}\text{C}$ or below, milk may be presumed to be free of water or may be confirmed as water free by tests, specified below. If the freezing point is above $-0,525^{\circ}\text{C}$, milk will be designated as “presumptive added water” and will be confirmed as added water or added water free by tests specified below. Evaluate extreme daily fluctuations in the freezing point of herd, pooled herd, or processed milk for presence of added water”.

“Presumed added water”, as described above, must be “confirmed” by means of tests on authentic milk samples obtained as specified in the AOAC METHODS.

After determination the freezing point of your sample via the milk analyzer, the added water is calculated using the following formula:

$$\text{AddedWater} = \frac{\text{FrPoint}_{\text{Base}} - \text{FrPoint}_{\text{Calc}}}{\text{FrPoint}_{\text{Base}}} * 100[\%]$$

Where:

FrPointBase is the basic freezing point

FrPointCalc is measured freezing point

Sample:

First variant

If you've entered for milk analyzer basic freezing point -0.520°C (according article 5.9 of the EU Milk Hygiene Directive 92/46/EEC), measured freezing point -0.540°C , using the above pointed formula you'll receive $-3,8\%$. Because it is not possible the added water to be negative value, the milk analyzer indicates 0% added water. The reason for this is the tolerance in the basic freezing point, reasons for which are described below.

If in the same milk we add $3,8\%$ water, and the basic freezing point is the same, the milk analyzer will measure freezing point -0.520°C , and will indicate again 0% added water.

Second variant

If you've entered for the device basic freezing point -0.540°C , measured freezing point -0.540°C , the milk analyzer will indicate 0% . When you add $3,8\%$ water, the device will indicate $3,8\%$ -added water. From the above mentioned follows that it is very important to enter correct basic freezing point in the device.

The device's results for added water may give information about doubt of added water in the milk and the exact value of this added water may be determined after a "cowshed sample" is taken and the result for the freezing point, measured by the milk analyzer of the "cowshed sample" is entered as basic freezing point in the formula for calculation of added water.

Then the result from this formula will give us the absolute value of the added water for the corresponding milk supplier.

APPENDIX INTERNAL PRINTER

(active only on request)

1. Printer mechanism, easy loading type.

Printing method	Thermal line dot printing
Paper width:	57,5±0,5mm
Printing density:	8dot/mm, 384dot/line
Printing speed:	50mm/s or 20line/s
Printing width:	48mm
Feeding speed:	50mm/s or 20line/s
Power:	DC 5V , 3A

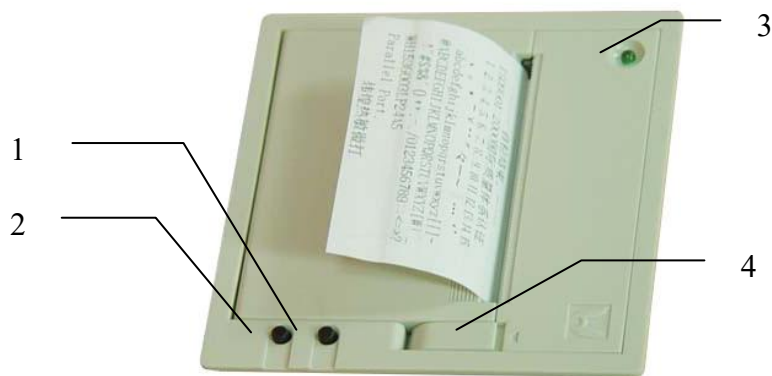

1. On/Off
2. FEED Button
3. Power LED
4. Cover opening

CONNECTING TO EXTERNAL PRINTER

MILKOTESTER MASTER can be connected to an optional serial printer for printing out the results. MILKOTESTER MASTER is set to work only with printers supplied by Milkotester Ltd. We warn you that the unit is not set to work with other types of printers.

1. To connect MILKOTESTER MASTER to the serial printer, follow the steps below:
2. Connect the provided power-out 12V DC cable to the POWER OUT 12 V (for printer) socket on the rear panel of MILKOTESTER MASTER.
3. Plug the jack on the other end of the cable into the matching socket on the back of the printer.
4. Connect the provided serial cable to printer to the Serial port to printer on the rear panel of MILKOTESTER MASTER.
5. Connect the other end of the cable to the serial connector RS 232 on the back of the printer.
6. Turn ON the POWER switch on the right panel of the printer. The printer is now ready for printing. From this moment on all measured results will be automatically printed out.

PC CONNECTION

Milkotester milk analyzers usually operate with two type communication port – RS232 COM and USB 2.0 connectors

It is recommended always to connect the **USB** connector to the analyzer before switching the device ON.

Usually computers contain one **COM PORT**, so the connection with the analyzer is trough **COM1**.

Port is used to connect with the program **MASTER DATA BANK**, which is included in each CD supplied with the ordered set.

First step is to use the CD that comes with any device. When started, the CD appears in picture and you have to click 'INSTALL' on the Microsoft NET Framework, and after that 'INSTALL' on the Milk data bank program.



When installed correctly, the program will make it's own shortcut on the desktop:

MILK DATA BANK.

After successful installation, connect the milk analyzer with USB cable and turn it ON.

The program works as below described way:

Starting the software, the following window will appear:

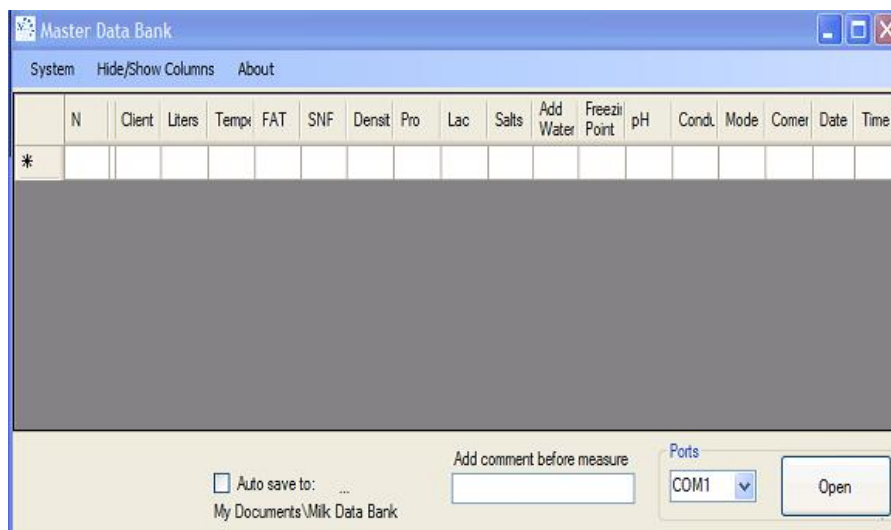

In the down right corner of the window you can see the COM PORT that is connected milk analyzer. Choosing button OPEN, both devices connect each other and every measurement made from the analyzer will be ordered in the table.

In checking (filling) the box AUTO SAVE, the program keeps the data automatically as Microsoft Excel file in new computer directory in “My documents”.

Hint: If the document in Excel is not in correct values you have to change the system separator from (,) to (.) (from comma to full stop sign). This you can change form Excel options menu: EXCEL OPTIONS > ADVANCED > SYSTEM SEPARATOR where the decimal separator must be full stop sign.

2.USB 2.0

After successful installation, connect the milk analyzer with USB cable and turn it ON. If it's on USB the device will find new COM PORT on your computer. Open Milk data bank and open the com port in the bottom right corner.



USB usage is the most popular way for PC connection for now. All milk analyzers from the Master series have embedded USB port. It operates at the same way as RS connector, but the difference is that the USB has to be installed from the CD (supplied with each analyzer) and it forms own COM PORT. For example, if your computer has not got RS port, the USB will form COM 1. If there is RS on your computer, the USB will form COM 2, if your computer has 10 communication ports, then the USB connector will create COM 11 and etc.



- Serial port bluetooth module (Slave)
- Bluetooth protocol: Bluetooth Specification v2.0+EDR
- Frequency: 2.4GHz ISM band
- Modulation: GFSK(Gaussian Frequency Shift Keying)
- Emission power: $\leq 4\text{dBm}$, Class 2
- Sensitivity: $\leq -84\text{dBm}$ at 0.1% BER
- Speed: Asynchronous: 2.1Mbps(Max) / 160 kbps, Synchronous: 1Mbps/1Mbps
- Security: Authentication and encryption
- Profiles: Bluetooth serial port

Depending on the software installed on your PC, there might be some difference in the pictures, but the principle is the same.
The PC software starts and chooses scanning of the available devices.

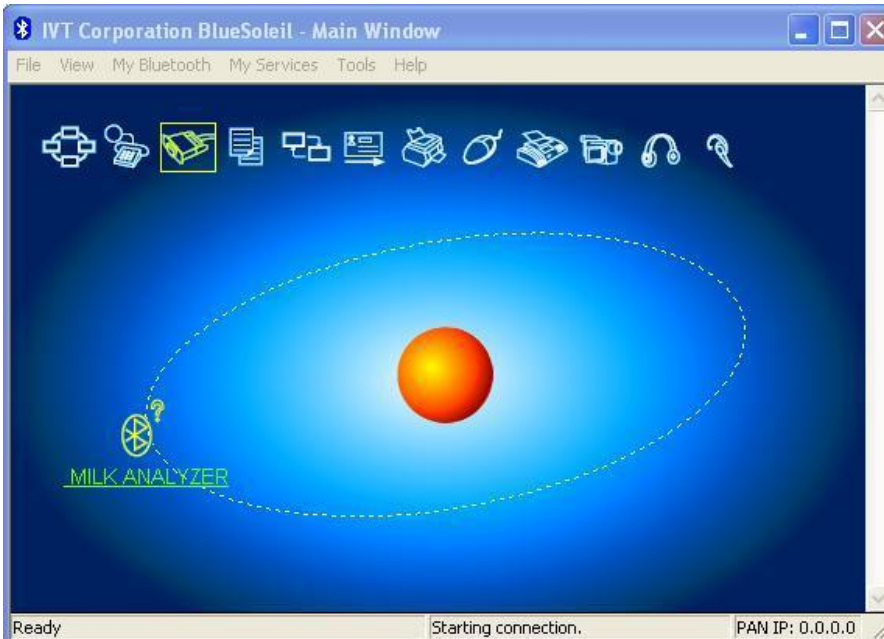

The software shows the available devices.

Double click on the milk analyzer you want to connect to. After that - right click and choose connect, as shown on the picture.

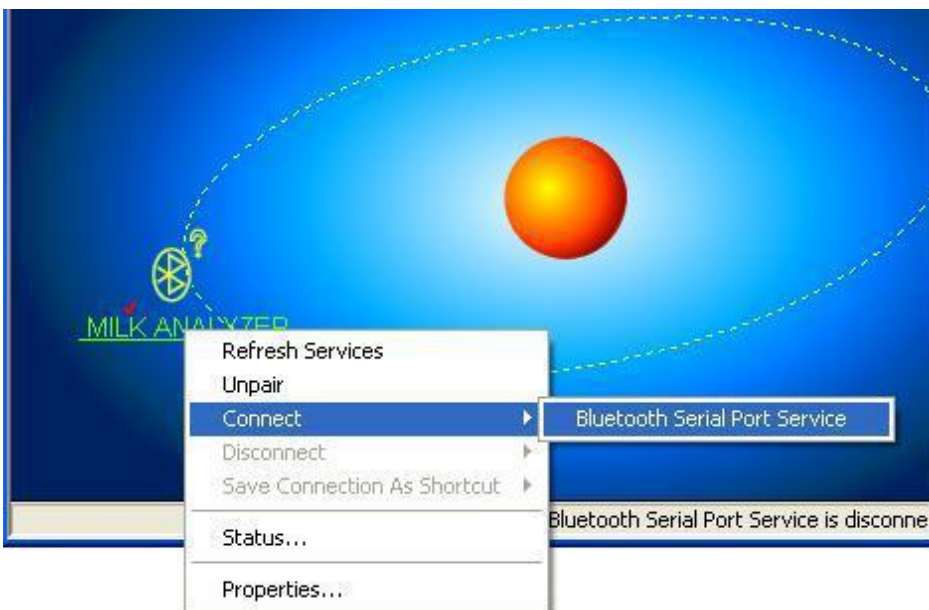

It requires password for confirmation - "1234"

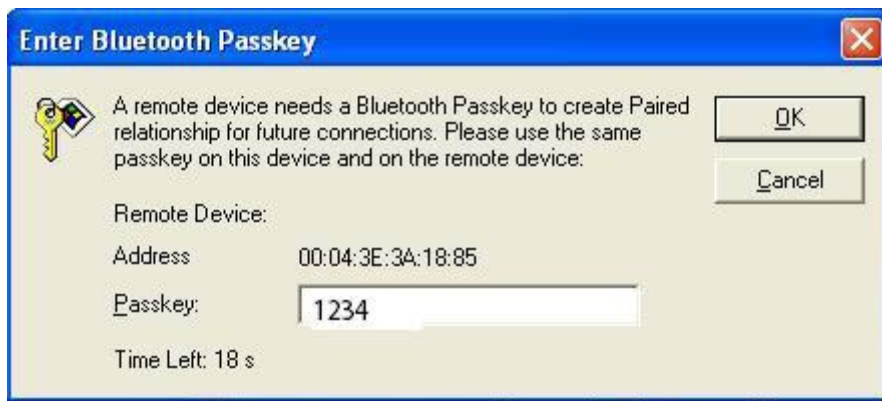

After setting up the connection, on the computer the following message will be shown for a moment (on the picture below). The transfer of data will be through "Serial Port (COM54)" in the case shown on the picture.

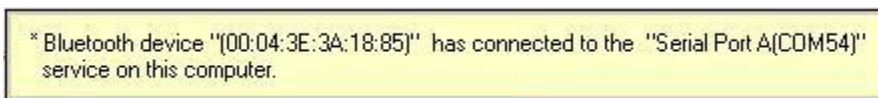

It is also visible from the Properties menu of the respective device.



Most probably for the different client numbers the number will be different (COM XX).

After that the work is the same as with standard "Serial Port". The data collection program, "Milk Data Bank", can be launched or another application for the milk analyzer.

CONNECTING FLASH DRIVE

Each analyzer of Milkotester LTD can be upgraded with the option 'flash drive' on customer request. With this option you can save your measurements instantly or collect them in the end of the working process without using PC connection, cables and installation discs. It is very handy when you work with the analyzer outside the laboratory, like for example in farm or other places with no computers or electricity. You can plug in your Master analyzer in the car lighter and collect measurements with the flash drive, inserting client numbers and liters. Every flash drive device can work with analyzer Master, not depending of memory size or manufacturer.

ATTENTION: Do not insert other USB devices in the flash drive input of the milk analyzer. The flash drive in the analyzer works only in file system FAT32.



Master Eco



Master Pro Touch

In Master Eco, the flash drive works when the 'auto save' option is turned ON. The memory of the analyzer is up to 50 measurements, but on the flash drive can be stored hundreds of measurements.

For Master LM2, LM3 and PRO you can choose the 'auto save' option or to save manually by pressing the 'SAVE' button on the keypad.

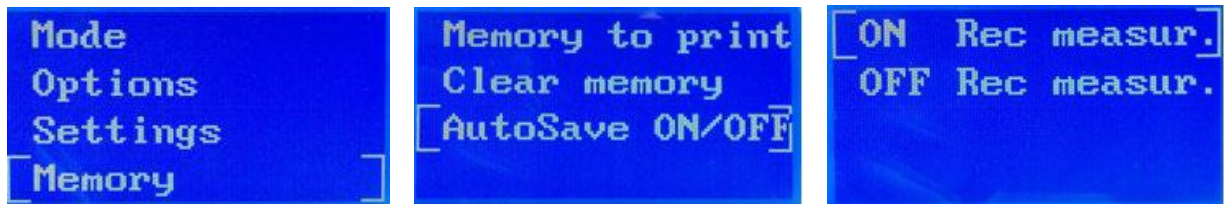

Master Pro and Master Pro Touch have internal memory for 500 measurements and have the option to send all saved results to flash drive. You can choose to save each measurement after the results are on display:

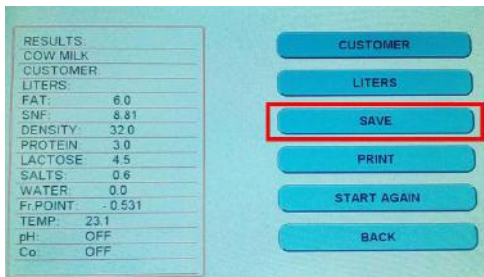

Or you can choose 'auto save' option and send all measurements to flash drive at the end of the day:



The results, saved in the flash drive are formatted in Microsoft Excel type of document and are named after the corresponding time and date of your milk analyzer Master.

Every single device from the Master series have integrated clock, and it is not an option that need customer request.

The saved document in your flash drive looks like this:

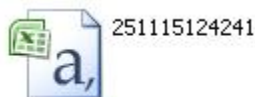

When you open that icon, table appears with all the measurements, saved by your choice or automatically.

The table looks like this:

E	F	G	H	I	J	K	L	M	N
FAT	SNF	Den	Pro	Lac	Salts	Add Wate	Fr_Point	pH	Conductiv
4.5	8.31	33.5	3.0	4.6	0.7	0.0	-0.530		
4.6	8.29	33.3	3.0	4.5	0.7	0.0	-0.530		
4.6	8.33	33.5	3.0	4.6	0.7	0.0	-0.533		
4.4	8.24	33.2	3.0	4.5	0.7	0.0	-0.525		
4.4	8.26	33.3	3.0	4.5	0.7	0.0	-0.527		
4.7	8.36	33.6	3.1	4.6	0.7	0.0	-0.535		
4.7	8.35	33.6	3.0	4.6	0.7	0.0	-0.534		
5.1	8.47	33.9	3.1	4.7	0.7	0.0	-0.546		
4.6	8.32	33.5	3.0	4.6	0.7	0.0	-0.532		
4.2	8.16	33.0	3.0	4.5	0.7	0.0	-0.519		
4.3	8.23	33.2	3.0	4.5	0.7	0.0	-0.524		
4.3	8.30	33.5	3.0	4.6	0.7	0.0	-0.529		
5.1	8.47	33.9	3.1	4.6	0.7	0.0	-0.546		
4.7	8.35	33.6	3.0	4.6	0.7	0.0	-0.534		
4.7	8.34	33.5	3.0	4.6	0.7	0.0	-0.534		
4.8	8.41	33.8	3.1	4.6	0.7	0.0	-0.539		
4.4	8.31	33.5	3.0	4.6	0.7	0.0	-0.530		
4.4	8.28	33.4	3.0	4.5	0.7	0.0	-0.528		
5.1	8.41	33.7	3.1	4.6	0.7	0.0	-0.542		
5.1	8.28	33.1	3.0	4.5	0.7	0.0	-0.532		

This table collects anything that the operator of the Master device decide to add in the measurements like for example number of a client or amount of liters for each sample of milk using Weighting scale, measurement of Conductivity or pH.

The milk analyzer Master do not need any special and empty flash drive, still it can record on any flash memory, not depending if there are other kind of files in it like music, pictures or documents. For each different day of measurements, the analyzer will create different file in the flash drive, named after the time and date that the measurement has been made until the capacity of the flash drive is full.

LIMITED WARRANTY

MILKOTESTER products are warranted against defects in materials and workmanship from the date of delivery through the duration of the warranty period. During the warranty period Milkotester will repair, or, at its option, replace any components (S) that proves to be defective at no charge, provided that the product is returned, freight prepaid, to MILKOTESTER.

This warranty does not apply if the product has been damaged by accident or misuse, exposed to radioactive or corrosive materials, foreign material penetrating to the inside of the product, or as a result of service or modification by other than MILKOTESTER. In case of a properly returned warranty registration card, the warranty period shall begin on the date of shipment to the authorized dealer. No other express or implied warranty is given by Milkotester Ltd.

As warranty legislation differs from state to state and country to country, please contact Milkotester or your local MILKOTESTER dealer for further details.

MILKOTESTER service center will repair the product free of charge subject to terms & condition mentioned below.

TERMS & CONDITION

1 It covers only weighing balance purchased from authorized channel and does not covers accessories like Battery, Adaptor, RS232 cable.

2. It does not cover the product which service manual and serial number has been altered, removed or defaced and/or is open by unauthorized person and found void sticker has been tampered.

3 This warranty is non-transferable and applicable only to first end user purchasing the product from authorized dealer.

4 .For repair based on this warranty you need to hand over this product or send this product to address mentioned in warranty card in original packing, enclosing copy of this warranty card.

5. Milkotester Ltd. shall not be liable for any consequential damages.

WARRANTY REGISTRATION



Milkotester Ltd.
49, Hristo Botev St.,
4470 Belovo, BULGARIA,
web: www.milkotester.com

NAME:

ADDRESS:

TEL.NO: SERVICE MENU NO:

SERIAL NO: PURCHASE DATE:

BRANCH/DISTRIBUTOR/DEALER CONTACT DETAILS

WARRANTY PERIOD:

STAMP / SIGN

Owners Signature/ Date

SEND YOUR WARRANTY CARD DULY FILL TO ABOVE ADDRESS FOR REGISTRATION